



Debut Tag III

Product Description

2020/04

Druid Technology Co., Ltd.

<https://www.druidtech.cn/en>

Table of Contents

Product description	1
Management software.....	1
Accessories.....	2
Turning on/turning off the device	3
Deploying the device	4
General information.....	6
Technical specification.....	6
Precautions	7

Product description

Debut delicacy livestock management terminal (hereinafter referred to as *Debut Tag III* or *device*) is a new generation of smart livestock product, which is developed independently by Druid Technology. It is capable of:

- collecting location-based data.
- collecting environmental data
- collecting animal behavior data

Using cellular network, Debut Tag III uploads the collected data to our cloud server where all data is organized and analyzed. You can use our web-based data center or App to connect to the cloud server to check the animal location, animal activity, and the environmental information at any time.

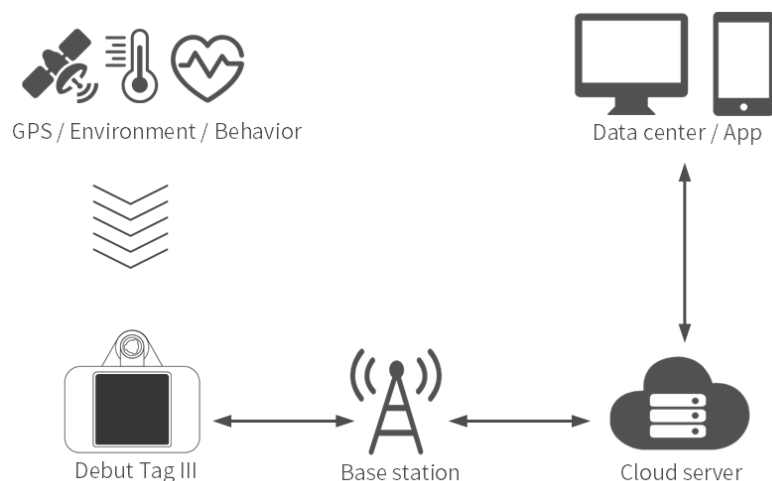

Note

There may be additional cost for using mobile network. Contact your local operator for detailed information.

Management software

You can connect to the cloud server through data center or App to check the data and manage your devices.

data center address:





Scan the QR code to install App:

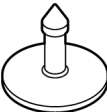

iOS users can search for at AppStore to download and install the App.

Accessories

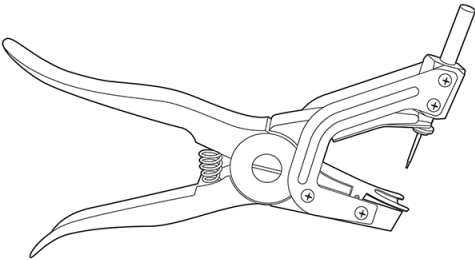
You may need the following accessories when you apply Debut Tag III to an animal.

Item name	Illustration
Ear tag	
	
Applicator	
Magnetic switch	

Turning on/turning off the device

Turning on the device

Place the magnetic stick close to the switch as shown below for five seconds.

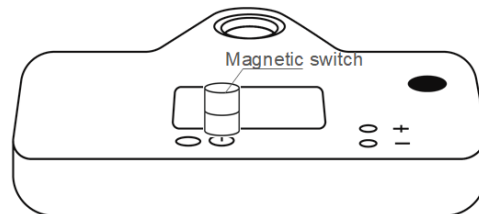

The green LED of the device starts blinking for about three seconds. After the LED light is out, the device is turned on. It is highly recommended to turn on the device before deploying it to the animal.

Turning off the device

Place the magnetic stick close to the switch as shown below for ten seconds.

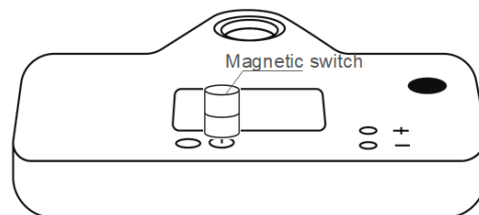

The red LED of the device is on for about three seconds. After the LED light is out, the device is turned off.

Deploying the device

This chapter gives the procedure to deploy the device to an animal.

Prerequisite

Before you start, make sure that you have turned on the device.

Steps

1. **Secure the animal properly.**

Calves must be eased into a chute with a head gate, halter and/or nose lead.

2. **Insert the pin of the applicator onto the back side of the male tag.**

3. **Fit the female tag on the device into the clip on the opposite arm of the applicator.**

The illustration below shows the correct position of the applicator, ear tag, and the device.

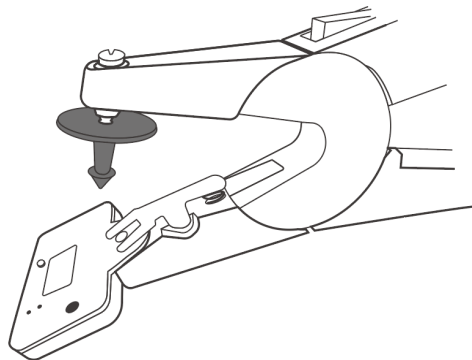

4. **Use proper hygiene and cleanliness.**

Dip the applicator and the device into the disinfectant, alcohol or hydrogen peroxide for instance, for at least 10 seconds.

5. **Clamp the applicator shut firmly and quickly to deploy the tag.**

Example

Illustrations below show the example of the device after it is deployed to an animal.

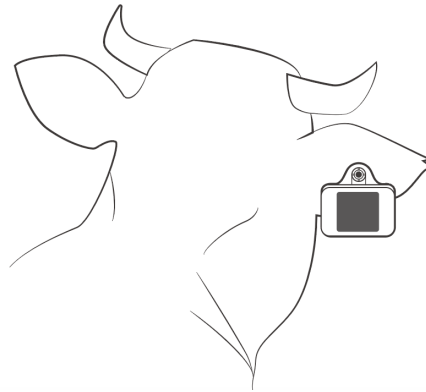

Attention

After the tag is deployed, pay extra attention to the area around the tag. Any excessive redness, swelling, or discharge you observe must be treated as a serious concern. Apply a topical disinfectant like rubbing alcohol or hydrogen peroxide to prevent infection. If infection symptoms do not begin to clear up within a week, contact a large animal veterinarian for a more advanced course of treatment.

General information

This chapter gives the technical specification, precautions and the frequently asked questions of Debut .

Technical specification

The table below shows the technical specification of Debut .

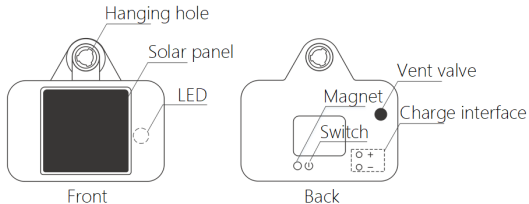
Appearance	
Measurement	40 mm × 64 mm × 12 mm
Weight	30 g
Power supply	Charging type: solar panel Cell type: polymer lithium Cell capacity: 210 mAh
Operating temperature	-18°C ~ 60°C
GPS precision	CEP (50%) 5 m
Communication module	2G: <ul style="list-style-type: none"> • Maximum uplink/downlink speed: 85.6 kbps/85.6 kbps • Supports SMS and international roaming
Sensors	Temperature sensor

	Acceleration sensor Light sensor Battery voltage sensor
Data collecting	Interval of environmental data (including GPS) collection: 1 h Interval of activity data collection: 10 min Interval of data transmission: 2 h
Storage	2 M
Ingress protection	IP 68

Precautions

Before using the product, read the following precautions carefully to prevent any misuse that may cause potential damages.

- Before deploying the device to an animal, make sure that the device is turned on.
- After the device is deployed, make sure that the solar panel of the device is not covered or blocked by the animal hair.
- Sometimes it may not be able to charge the device due to bad weather, thus the device cannot work properly. When the weather turns clear, the battery is charged and the device works properly again.
- Temperature of the storage place must be lower than 60°C.
- Do not store the device near a strong magnetic field (for example, a transformer).
- Do not store the device at a high place. Falling from a high place can cause device damage.

- Do not turn on the device at a place with poor GPS signal or network connection, or the device will keep searching for signal, which can increase power consumption.
- Do not disassemble the device. Disassembling the device may affect the warranty.
- The device contains lithium battery. The battery must be recycled or disposed properly. When you dispose your device and/or other batteries, make sure that it is done sustainably.